

Martin Yale Mark VII High Speed AutoFolder

Instruction Manual



Provided by

MyBinding.com
When Image Matters.

Call Us at 1-800-944-4573



Model Mark VII AF Air-Feed AutoFolder™

Installation, Operation & Maintenance Instructions

Specifications

Machine	
Feeding Method	Continuous Bottom Air/Vacuum
Feed Rate	up to 35,000 sheets/hour*
Sheet Capacity	300*
Paper Weights	16 lb. Bond – 80 lb. Index
Max Paper Size	14" x 20" (35.6cm x 50.8cm)
Min Paper Size	3.5" x 4.25" (8.9cm x 10.8cm)
Max Fold Length	
1st Fold Plate	14.5" (36.83cm)
2nd Fold Plate	11" (27.94cm)
Min Fold Length	
1st & 2nd Fold Plate	2.19" (5.56cm)
Digital Counter	job & life count, resettable
Electrical (USA)	115VAC 60 Hz, 4 amps
Dimensions (LxWxH)	49.16" x 23.25" x 19.31" (124.9cm x 59.1cm x 21.9cm)
Machine Weight	153 lb. (69.4 kg)
Pump	
Electrical	115VAC 60 Hz, 15 amps
Dimensions (LxWxH)	21.5" x 13" x 11.5" (54.6cm x 33cm x 29.2cm)
Pump Weight	87 lb. (39.5 kg)
Total Shipping Weight	293 lb. (132.9 kg)

*8.5" x 11" or A4 20 lb. copy paper

Table of Contents

Introduction	page 1
Important Safety Notes	page 1
Initiation	page 1
1.0 - Nomenclature	page 2
2.0 - Machine Setup	page 2
3.0 - Machine Settings	page 3
3.1 - Paper Guides	page 3
3.2 - Separator Gap	page 4
3.3 - Paper Stops	page 4
3.4 - Conveyor	page 4
3.5 - Fold Roller Gap	page 5
3.6 - Folding Speed	page 5
3.7 - Accessory Assembly	page 5
4.0 - General Operation	page 7
4.1 - Single Folds	page 7
4.2 - Double Folds	page 7
4.3 - Using the Dejam Handle	page 8
4.4 - Reversing the Separator	page 8
4.5 - Adjust Conveyor Belts	page 8
5.0 - Maintenance	page 8
5.1 - Fold Rollers	page 8
5.2 - Exit Wheels	page 9
5.3 - Lubrication	page 9
6.0 - Troubleshooting	page 10

Serial No. _____







Introduction

Thank you for selecting the Mark VII High-Speed AutoFolder. Your folder and all the components were 100% tested at our factory. We folded, perforated, and scored paper, performing over 100 individual functional checks.

Please read and understand this manual completely before attempting to operate the folder. This will prevent most common problems and eliminate operator-associated errors. Most performance related problems are due to inexperience with the wide range of machine adjustments which are available to you. Understanding these instructions is vital to years of excellent performance by a quality-tested machine.



IMPORTANT SAFETY NOTES

-  << The machine may not be operated by more than one person at any given time! The machine was designed for safe operation by "one person only".
-  << Danger of injury! Keep all loose articles of clothing, ties, jewelry, long hair or other loose objects away from opening!
-  << During the folding process no other work may be performed on the machine (for example cleaning, etc.).
-  << Danger of injury! Never insert fingers into opening.
-  << The machine is not a toy, and is not suitable for use by children! The overall technical safety concept of this machine (dimensions, feed openings, etc.) does not provide for any guarantee regarding hazard-free operation by children.
-  << In case of danger switch the machine off with the mains switch, or unplug the machine.
-  << Always unplug the machine from the mains power supply before opening the machine. Repairs may only be performed by trained personnel!

 **Warning:**
Moving parts can crush and cut!

 **Warning:**
Electrical Hazard!

INITIATION

SCOPE OF APPLICATION:
The Mark VII High-Speed AutoFolder™ is a machine for the folding, scoring, or perfin of common sized paper.

 **The unit should be fed with paper!**
Folding other types of materials can cause injuries or may damage the folder (e.g. destruction of the folding system).

INSTALLATION:
- Unpack and set machine upright.
- See Section 4.0 Machine Setup

 **The socket outlet shall be installed near the equipment and shall be easily accessible!**
Only operate the machine in enclosed rooms at temperatures between 10°C and 25°C!
Keep enough distance to the surroundings when installing the machine.

1.0 Nomenclature

The nomenclature below will be used to describe assemblies and parts of your folder found in Fig. 1

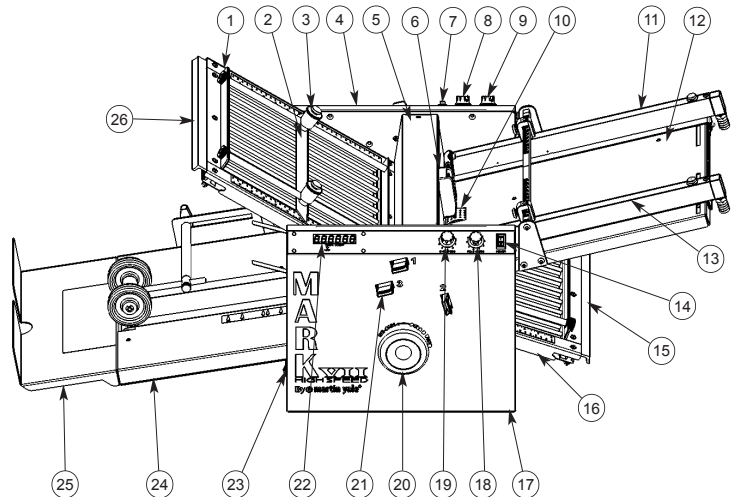

Fig. 1

- | | |
|------------------------------|------------------------------|
| 1. 1st Fold Plate | 14. On/Off Power Switch |
| 2. Paper Stop | 15. Fold End of Fold Plate |
| 3. Thumbscrew | 16. 2nd Fold Plate |
| 4. Right Side Cover | 17. Left Side Cover |
| 5. Roller Cover | 18. Roller Speed Control |
| 6. Air Separator Carrier | 19. Conveyor Speed Control |
| 7. Pump On/Off | 20. Dejam Handle |
| 8. Paper Guide Pressure Knob | 21. Roller Adjusting Levers |
| 9. Feed Drum Vacuum Knob | 22. Digital Counter |
| 10. Air Feed Drum | 23. Circuit Breaker |
| 11. Right Air Paper Guide | 24. Conveyor |
| 12. Feed Table | 25. Conveyor Tray |
| 13. Left Air Paper Guide | 26. Bypass End of Fold Plate |

2.0 Machine Setup

Un-pack the folder, then check the list of contents below:

- Box 1 - 1st Fold Plate Assembly
- Box 2 - 2nd Fold Plate Assembly
- Box 3 - Catch Tray, Conveyor & Feed Table
- Box 4 - Stack Wheels, one set of Perforating & Scoring Accessories, Power Cord, one 5/32" & one 1/8" hex wrench
- Box 5 - Pump Assembly & Hoses Note: The pump assembly weighs 80 lbs. Use two people or a mechanical lifting device to lift.

Begin the machine setup as follows:

With the smaller (1/8") hex wrench, loosen the set screws on the Guide Finger collars and rotate the finger up to a horizontal position, then re-tighten the collars. See Fig. 2

Now plug the Power Cord into the Power inlet in the lower corner as shown in Fig. 2.

CAUTION: Do not plug the power cord into the power source until basic setup is complete.

Next, position the Conveyor near the back of the folder and plug the

conveyor motor connector into the motor inlet shown in Fig. 2. The connector is keyed and will only go one way. Push (do not force) it in then turn the locking ring clockwise to lock in place. Now lift the Conveyor and push it under the Guide Fingers to engage the pins into the slots on the front edge of the Conveyor. Lower the back of the Conveyor to fully engage the pins into the side slots on the Conveyor. Attach the Conveyor Wheels Assembly using the T-handle and flat washer provided. Attach the Catch Tray with the keyholes over the Conveyor studs with self-locking nuts. The nuts can be adjusted for a

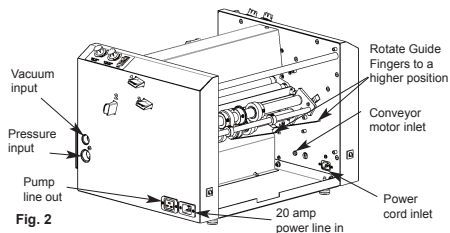

Fig. 2

Troubleshooting (cont.)

6.8 Poor Perforating or Scoring	<ol style="list-style-type: none"> Loose Set Screws in Hubs Mis-aligned Perforating Blade, Backup Hub/Collars or Stripper Finger Running speed too fast 	<p>Tighten all set screws</p> <p>Check all accessory components for correct positioning. See Section 3.7 Figs. 14-17.</p> <p>Depending on the paper, it may be necessary to perforate or score at slower speeds.</p>
6.9 Irregular or Non-parallel Scoring or Slitting	<ol style="list-style-type: none"> Exit wheels are loose or worn Paper is not cut parallel Paper guides are not perpendicular to rollers 	<p>Tighten set screws and check to see if paper will slip between exit tires; replace in sets if needed.</p> <p>Measure paper width at the top and bottom of the page.</p> <p>See Section 3.1</p>
6.10 Marks on the Paper	<ol style="list-style-type: none"> Excessive dirt or ink Ink not dry 	<p>Check the fold rollers and the exit wheels for buildup. Clean as needed. See sections 5.1 & 5.2</p> <p>Paper printed with rubber-based inks and glycerin based fountain solutions that do not require overnight press clean-up generally will not fully dry for some period of time. Wet ink will "smudge" as the printed stock is rubbed against each other at the retarder roll. Proper ink chemistry along with increased drying time and lowered humidity can help reduce this problem.</p>
6.11 Not enough pressure or vacuum	<ol style="list-style-type: none"> clogged hoses or orifices Dirty filters 	<p>Check all hoses, Feed Drum and Paper Guides for obstruction.</p> <p>See section 5.4</p>

6.0 Troubleshooting

The following list of possible problems and resolutions is provided as a guide to the user for self-diagnosis. If your problem cannot be solved here first, please contact Customer Service for technical assistance at the phone number listed at the end of this document.

6.1 Folder or Pump Does Not Run	<ol style="list-style-type: none"> 1. No power 2. Folder or Pump Circuit Breaker Tripped 3. Loose Wiring 4. Loose or Broken Motor Belt 5. Failed Electrical Component 	<p>Check power cord at both ends, building power supply outlet, and circuit breaker or fuses.</p> <p>Allow to cool a few minutes, then reset by pushing in the button. Repeated tripping indicates a more serious problem such as a short circuit, paper jam or low supply voltage.</p> <p>If the side cover was removed for service, wiring may have come loose or disconnected.</p> <p>Adjust or replace as necessary.</p> <p>Check speed control, circuit breaker, and motor. Replace if necessary.</p>
6.2 Paper Will Not Feed	<ol style="list-style-type: none"> 1. Tight Separator Adjustment 2. Worn Separator 3. Feed Drum Clutch 4. Paper Guides Too Tight 5. Vacuum timing is wrong 	<p>See Section 3.2</p> <p>See Section 4.4</p> <p>With the machine OFF, test the clutch bearing in the Feed Drum by rotating with your finger. It should spin freely in the feeding direction and lock in the opposite direction. If the drum turns both ways or is hard to turn forward, the clutch is worn-out and must be replaced.</p> <p>See Section 3.1</p> <p>The Vacuum timing is preset and should not require adjustment. If it is inadvertently changed or you suspect it is wrong, call Martin Yale customer service for instructions to set timing at (260) 563-0641 or toll free (800) 225-5644.</p>
6.3 Fold Length Varies	<ol style="list-style-type: none"> 1. Speed Adjustment 2. Loose Paper Stop 3. Incorrect Roller Gap 4. Dirty Rollers 	<p>The length of fold will vary slightly with speed changes. See Section 3.</p> <p>See Section 3.3</p> <p>See Section 3.5</p> <p>See Section 5.1</p>
6.4 Paper Jams or Tears	<ol style="list-style-type: none"> 1. Double Sheet Feeding 	<p>Loose Separator adjustment, see Section 3.2.</p>
6.5 Wrinkling Paper	<ol style="list-style-type: none"> 1. Tight Separator Adjustment 2. Feed Drum Clutch 3. Misaligned or Worn Fold Rollers 	<p>See Section 3.2</p> <p>See Section 6.2. #3</p> <p>Remove the roller cover, feed table, both fold plates and any paper shims from the adjusting levers. Rotate the rollers while inspecting the pinch line between each roller. Placing a light behind the rollers will make this much easier to see any gaps between the rollers. Gaps in random areas indicate worn rollers while a straight or tapering gap from one end to the other indicates misaligned rollers. If such gaps are apparent, call for technical assistance.</p>
6.6 Paper Jams at the Exit	<ol style="list-style-type: none"> 1. Stack Wheels Dislocated 2. Exit Rollers or Guide Strips Dislocated 3. Loose Set Screws in Exit Rollers 4. Conveyor Belts Slipping 5. Paper Sticking to Perforating Blade 	<p>See Section 3.4. <i>Always check the stack wheel position before starting the folding operation!</i></p> <p>See Section 3.7</p> <p>Tighten all set screws</p> <p>See Section 4.5 Fig. 27</p> <p>Install the stripper finger provided. See Section 3.7 Fig. 15</p>
6.7 Crooked Folds	<ol style="list-style-type: none"> 1. Paper is not square 2. Loose or Mis-aligned Paper Guides 3. Dirty Rollers 4. #1 Roller Gap too wide 	<p>The paper stops can be adjusted to compensate. See Section 3.3</p> <p>Check paper guides for proper adjustment. See Section 3.1</p> <p>See Section 5.1</p> <p>Thin or stiff paper may skew if the gap is not tight enough. See Section 3.5</p>

more desirable fit with a 3/8" wrench (not included). See Fig. 3

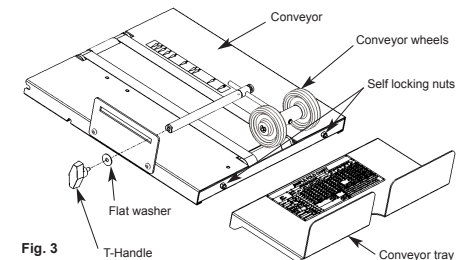

Fig. 3

The 1st & 2nd Fold Plates and the Feed Table are installed in the same manner as the Conveyor, on pins and slots. Carefully install the 1st Fold Plate down onto the front pins and lower onto the rear pins, making sure the side slots fully engage the pins. Both Fold Plates can be turned around to use in the folding or bypass position. Repeat this process for the 2nd Fold Plate.

Install the Feed Table onto its pins in the same way. Take care to engage the gear drive on the left side and slide the feed drum under the separator carrier.

Loosen, but do not remove, the two cross head screws holding the Hose Lock Plate and slide it to the right. Install the two paper guide hoses onto the fittings located at the ends of the paper guides (the longer hose goes on the left side). Insert the opposite ends with the o-ring fittings into the two lower holes next to the Lock Plate. Insert the vacuum hose (attached to the Feed Table) into the smaller hole next to the Lock Plate. Slide the Lock Plate to the left to capture the o-ring fittings and tighten the two screws.

CAUTION: Be careful not to bump the Feed Table into the Separator Carrier when installing. This could nick the surface and prevent proper feeding of the paper stack.

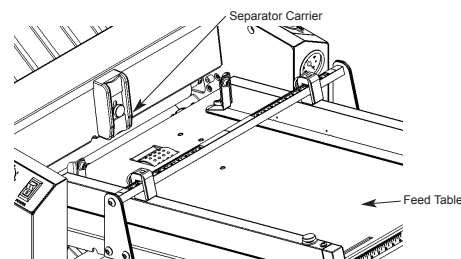

Fig. 4

Position the Pump Assembly on the floor near the folder or on the lower shelf of the MarkVII Folder Cart (provided separately). Push the vacuum and pressure hoses on to the appropriate fittings provided on the top of the pump. Install the other two fittings into the tapped holes in the Right Side Cover (see fig. 5) Note: The threads and hoses have been pre-lubricated with a special silicone sealant. Push the vacuum and pressure hoses onto the fittings on the Right Side Cover. Plug the Pump Supply Cord into the male receptacle of the Right Side Cover and the other end into a 20 amp 115V power outlet.

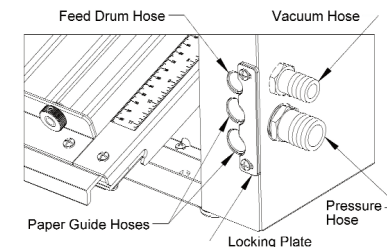

Fig. 5

3.0 Machine Settings

Now that the folder is fully assembled, it is ready for the final setting adjustments to be made before beginning a folding operation. The procedures below are outlined step-by-step to make this process as easy as possible.

CAUTION: For personal safety, always unplug the power cord when making adjustments to the folder.

3.1 Setting the Paper Guides

The two rules on the feed table have been precisely positioned to allow perpendicular alignment of the paper guides to the fold rollers. The paper guides are equipped with two locking knobs to give full control over the feeding system. To move the guides, loosen the knobs and slide the paper guide along the square shaft and slot. Align the inside edge of the paper guide clamp block with the corresponding mark on the rule for the desired paper width. Also align the edge of the Paper Guide Indicator on the same mark on the rule located on the back side of the Feed Table. See Fig. 6.

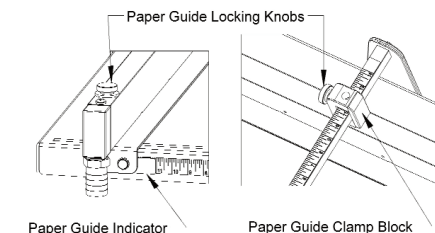

Fig. 6

Note: The Paper Guide Indicators are adjustable for squaring purposes but are preset to be perpendicular to the rollers and should not be moved under normal circumstances.

Lay a sheet of the paper to be folded between the guides to test the fit. The guides should be parallel to the edges of the paper and slightly wider. If the guides are too tight, feeding will be interrupted or stopped. Now place a stack of the paper to be folded between the guides; it should be able to slide between them without binding. Final adjustment may be required. Hint: when adjusting the width of the paper guides, leave one guide fixed and move the opposite side only. Always jog the paper stack to maximize the accuracy of feeding.

3.2 Setting the Separator gap

The Separator adjustment thumbscrew located in the middle of the Separator Carrier (see Fig. #6) adjusts the gap between the Feed Drum and the Separator. Typically, the gap should be set at one sheet thickness of the paper being used.

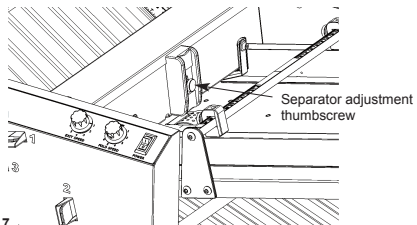

Fig. 7

To set, place a sheet under the Separator and loosen the Adjusting Thumbscrew to allow the Separator to fall down onto the sheet. Without putting additional downward force on the Separator, tighten the Adjusting Thumbscrew securely. Pull the sheet out to test the gap. It should pull out without dragging the tips of the Separator. Visually inspect the gap between the tips and the Feed Drum to make sure they are equal. If the gap is uneven, skewing may occur. If the gap is too small, hesitant or non-feeding will occur. If the gap is too large, multiple feeding will occur. See Fig. 8

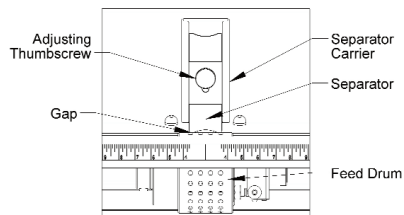

Fig. 8

CAUTION: When removing or replacing the Feed Table from the machine, always raise the Separator to its highest position to protect it and the Feed Drum from damage.

Fine tuning the separator gap can now be made with a test run of several sheets once fold plates and conveyor have been set up as outlined below.

3.3 Setting the Fold Plate Paper Stops

The 1st and 2nd Fold Plates are reversible to perform either in a folding position or in a bypass position where the paper is guided

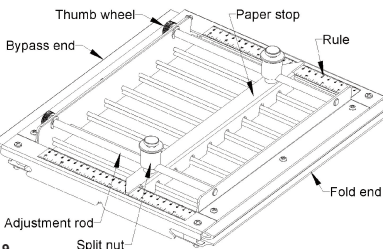

Fig. 9

past the fold. With one table in bypass position, a single fold can be made. If both tables are in bypass position, no folds are made (useful for scoring or perforating without folding). See Fig. 9. The length of the fold is determined by the position of the Paper Stop. This location is read directly from the fold rules, which are located on either side of the fold tables. These rules are graduated in fractional inches and millimeters.

A reference chart is located on the Conveyor Tray that gives settings for common folds of various paper sizes. The table below is provided to convert the decimal inch settings on the chart to the nearest millimeter.

Inch	Millimeter
2.25	57
2.75	70
3.00	76
3.50	89
3.67	93
4.25	108
4.50	114
4.67	119
5.00	127
5.50	140

Inch	Millimeter
5.67	144
6.02	153
6.67	169
7.00	178
7.35	187
8.50	216
9.35	237
10.00	254
11.00	279
11.35	288

Note: Rules are for reference only. They are carefully applied to accurately position the paper stop parallel to the fold rollers but adjustments will be necessary for various fold speeds, paper types and non-square paper.

Follow these steps to set the paper stops:

1. Loosen the thumbscrews (counterclockwise) on top of the paper stop assembly 2-3 full turns. A spring under each split-nut helps to disengage it from the adjustment rod threads.
2. Grasp the split-nuts, lift and slide the paper stop assembly parallel along the adjustment rods to the desired position.
3. Semi-tighten the thumbscrews (clockwise) and use the knurled thumb wheels on the end of the adjustment rods to dial in each end of the paper stop. Tighten the paper stop thumbscrews.
4. Make a test fold and check the fold accuracy. To fine tune the fold setting, loosen the thumbscrews $\frac{1}{4}$ - $\frac{1}{2}$ turn and adjust the paper stop with the thumb wheels. Always re-tighten the thumbscrews, as a loose fitting paper stop will give poor results.

Hint: The leading edge of the paper must engage the paper stop evenly or wrinkling in the fold may occur. Before re-adjusting the paper stops, first make sure the paper is being fed perpendicular to the rollers without skewing. Refer to 2.1.2 Setting the Paper Guides.

For out-of-square paper, feed a sheet of paper by hand using the dejam handle and adjust the 1st paper stop to align with the leading edge. Make sure the paper stack is placed in the fold table the same way for remainder of the folding operation.

3.4 Setting the Conveyor

See Fig. 3. The Fold Chart located on the conveyor tray includes a stack wheel position setting indicated by an arrow and number from 1 to 10 for various common folds. There is a corresponding label on the conveyor (see Fig. 10) that aligns the contact point of the stack wheels with the arrow. This is a reference point only, as varying speeds, fold styles and paper types will necessitate the need to adjust this position for each folding job.

In general, as the material exits the four exit rollers on the accessory assembly, it should clear the bottom set of exit rollers just before engaging the pinch point between the stack wheels and

Begin by removing any accumulated paper dust with a vacuum and/or soft brush. Do not use compressed air to remove paper dust, as this may force the dust into the bronze bearings and gearing.

To remove glaze and build-up of ink or other foreign material it is recommended to use a polyurethane compatible blanket and roller wash available from your local printing supply merchant. **Never use alcohol, harsh solvent based cleaners, or abrasives as these will harm and/or destroy the polyurethane and void the machine's warranty.**

As an alternative, use only a solution of warm water and mild soap such as dish detergent. Scrub each roller its entire length using a clean cloth or soft nylon brush, rotating the roller until the entire surface is clean before moving to the next roller. After cleaning the rollers, dry thoroughly before using.

5.2 Exit Wheels

Like the fold rollers, the exit wheels are made of polyurethane and should be cleaned in the same manner. Use a soft cloth dampened with the cleaning solution to wipe the surface of the wheels. Do not apply excessive pressure as the polyurethane tires and can shift on the hub, causing misalignment.

5.3 Lubrication

The fold rollers are mounted in sealed ball bearings and do not require lubrication. There are eight other shafts mounted in bronze bearings that will require occasional lubrication. **Use only SAE 30 grade motor oil** sparingly on the surface of the bronze bearings and/or where the shaft enters the bearing. The bronze is porous and will absorb the oil.

WARNING! Do not use light grades of oil such as machine oil as they will thin out and seep from the bearings under heat and pressure. Never use spray-on penetrating lubricants as they will dissolve and wash out the oil in the bronze. Either of these or other unapproved types of lubricants can cause premature wear or failure of the bearings and void the machine's warranty.

The bronze bearings are located in the following areas;

1. Feed wheel shaft on the feed table
2. Two accessory shafts on the accessory assembly
3. Two conveyor belt shafts on the conveyor assembly
4. Gear driven shaft for feed table on the left side frame
5. Gear driven shaft for accessory assembly on the right side frame

Note: To adequately lubricate the two gear driven shafts, it will be necessary to remove the side covers to obtain access to both sides of the shafts. There are six flat head screws securing each cover that use the included 5/32" Allen wrench. Be careful of the attached wires when removing the control side cover.

Once the side covers are off, it would be a good time to check the lubrication of the gearing. The gears are lubricated with a thin layer of grease. Grease tends to attract dust and in time will require cleaning and re-lubrication. Remove old grease and dust with a plastic brush and cloth. Reapply grease sparingly to all the teeth on the gears with a small stiff brush. Excessive grease will sling off at the high speeds and contaminate surrounding components.

5.4 Pump Filters

The pump is equipped with internal air filters that will eventually

require replacing. In the event pump performance decreases, the filters may need replacing. Call Martin Yale Customer Service for details at (260) 563-0641 or toll free (800) 225-5644.

paper length, resulting in the zigzag configuration. For a letter fold, the 1st fold plate paper stop is set at 2/3 the paper length and the 2nd stop at 1/3, resulting in the overlapping fold style. **Note: the letter fold measurements are not exactly 2/3 and 1/3 as this would cause interference on the inside of the 2nd fold with the paper edge. Always leave about 1/16" (1.6mm) space here to allow trouble free folding.** See Fig. 24

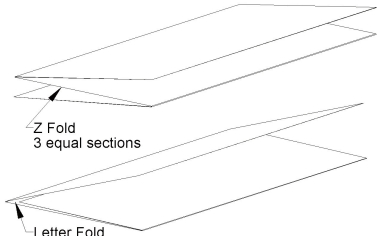

Fig. 24

4.3 Using the Dejam Handle

The dejam handle is available in the event that the machine requires manual motion to help clear paper that has become jammed in the rollers or to manually turn the rollers for setup and maintenance. Before using the dejam handle, first unplug the power cord. Remove the 1st and 2nd fold plates and feed table if necessary. Pull the handle outward while turning slightly to engage the gearing on the rollers. Counter-clockwise rotation will turn the rollers in reverse of normal operation which is typically the best way to clear a jam. Remove the jammed paper once it is freed from the rollers. It may also be necessary or easier to remove the feed table, fold plates, accessory assembly or the conveyor assembly to clear jams.

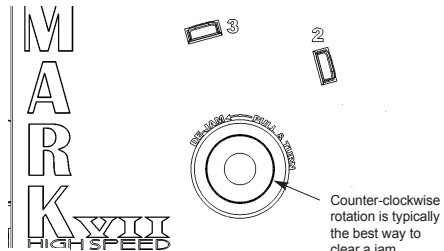

Fig. 25 martin yale®

4.4 Reversing the Separator

Eventually, the tips of the Separator will wear down to the point where adjusting the gap is no longer possible. When this happens, remove the thumbscrew and washer and flip the Separator over to use the new end. Once both ends are worn, replace the Separator. **WARNING:** The slot in the Separator is designed to limit the travel of the Separator to prevent the metal backing from touching the Feed Drum. Any modification to the Separator, thumbscrew or Separator Carrier to overcome this design will void the warranty.

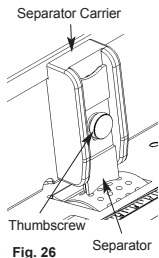

Fig. 26 Separator

4.5 Adjusting the Conveyor Belts

In time, the conveyor belts may stretch and begin slipping or not tracking straight. To correct, remove the conveyor assembly from the machine, **don't forget to unplug the power inlet connector from the side of the machine!** Turn the conveyor assembly over and locate the two socket head screws that tension the belts. Loosen the locknuts with a 3/8" wrench (not included) and re-tension the belts by gradually tightening the socket head screws. If the belts were tracking straight, tighten both screws equally. If the belts were skewing, tightening one side will cause the belts to track away from that side. Once adjusted, tighten the locknuts. See Fig. 27.

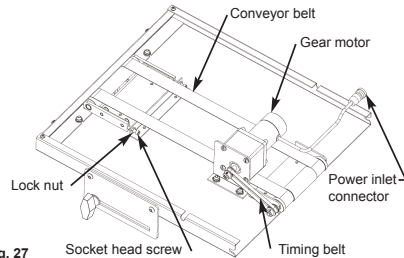

Fig. 27

Important! Do not over tighten the belt tension as it may slow the speed of the conveyor by overloading the gear motor or cause the timing drive belt on the gear motor to slip, thereby damaging the teeth of the belt or pulleys.

5.0 Maintenance

Warning! Rotating parts and electrical components will be exposed when the side covers are removed. **Always disconnect the power cord before servicing.**

A routine maintenance schedule of the following topics will ensure many years of precision performance and help prevent operational problems.

5.1 Fold Rollers

The fold rollers are the heart of the machine and require the most attention. They are constructed of high quality, precision ground polyurethane and should give many years of service provided they are properly maintained.

To clean the rollers, first disconnect the power cord and remove the feed table, fold plates, accessory assembly, and roller cover to gain easy access to all four rollers. See Fig. 28

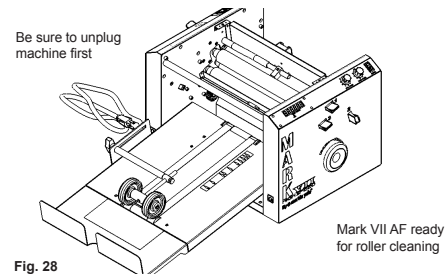

Fig. 28

conveyor belts. This is a critical setting, especially at high speeds as jamming can occur rapidly. There are two places to adjust the stack wheels position, a thumbscrew to slide the small shaft and a T-handle to slide the large shaft. The rotating joint in the large shaft allows a full range of positions along the conveyor belts. See Fig. 3.

The conveyor assembly is independently powered with its own gear motor. This feature allows full adjustability to the stacking of folded material at all speeds. The conveyor speed control turns ON & OFF with the motor speed control switch. To affect the way the conveyor stacks, simply change the conveyor speed at any given folding speed. Slower conveyor speeds result in tighter stacking. Conveyor speeds too slow or too fast will result in jams or irregular stacks. As a general rule, the overlap of the stacked material should be between 1/2" - 1", depending on fold styles and paper types.

Fold Styles	Fold Plate	SIMPLE FOLD CHART									
		USA Paper Sizes (inch)					ISO Paper Sizes (Millimeter)				
		Letter	Legal	Letter	14 x 20	A5	A4	A3	A2	A1	
Letter	1	6.02	7.35	8.35	11.35	148.0	188.0	230.0	297.0	322.5	
Fan (Z)	1	3.00	3.67	4.17	5.67	6.97	70.0	90.0	140.0	161.0	
Double Parallel	2	2.25	2.75	3.00	4.25	5.00	74.0	105.0	121.0	170.0	
Single (Half)	1	4.50	5.50	7.00	8.50	10.00	148.5	188.5	230.5	241.5	
Church	1	Bypass		7.50	8.50	11.00	148.5	188.5	230.5	241.5	
Engineering	2	Bypass		5.50	6.50	8.00	110.0	140.0	170.0	200.0	

Fig. 10 Fold chart label on Conveyor Tray

3.5 Setting the Fold Roller Gap

The Mark VII is equipped with an adjustable roller gap system that permits the widest range of folding options on various paper types and weights. By inserting paper shims into the roller adjusting levers, the sharpness of the fold crease can be lessened or increased. The rollers are factory set to just touch each other without pressure.

Each set of numbered Shim Levers protruding from the side covers represent the sequence and the roller gap the paper will be passing through. For a typical folding operation such as a letter fold in 20# copy paper, cut twelve 1" x 3" strips of that paper. As there is a single sheet passing through the first roller gap, insert one strip under each #1 Shim Lever. Once folded, there will be two sheets passing through the second gap, ergo two strips in the #2 Shim Levers. The last fold will have three sheets, requiring three strips in the #3 Shim Levers. See Fig. 11

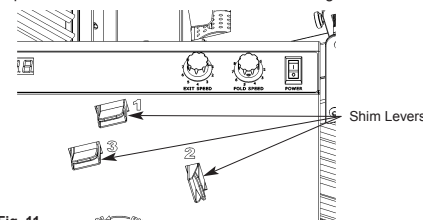

Fig. 11 The number of paper strips can be altered for personal preference, but it is recommended to always use the same on both sides to keep the roller gap even. Note: the #1 Shim Lever is the most critical as there is only one paper thickness passing through the roller gap. If the paper is not adequately pinched between the

first roller gap it may slip or skew, resulting in a crooked fold. To test this, start a sheet by hand using the dejam handle. Once it has entered the first set of rollers, try to pull it back while holding the rollers with the dejam handle. If it slips, remove the paper strips from the 1st shim levers.

3.6 Setting the Folding Speed

The Mark VII High-Speed AutoFolder is capable of folding 35,000 sheets of 8 1/2 X 11 or A4 paper per hour. That's almost 10 sheets per second! However, not all paper is created equal and therefore the actual folding speed of any given size or type of paper cannot be predicted or guaranteed.

The fold plates and paper stops have been designed to maximize folding speed, limited only by paper condition or quality. Remember, only fold at speeds the paper can tolerate.

The first sign of excessive folding speed is usually damage to the leading edge of the paper where it engages the 1st paper stop. This is evident when small creases or tears occur along the edge of the paper from impacting the cut-outs in the paper stop around each set of guide rods.

Humidity plays a large role as well. Some paper will fold at high speeds when dry but fail at those speeds after absorbing moisture. Storing your paper in a low humidity atmosphere will improve the folding speed greatly.

Obtaining the ideal folding speed for any given paper is something only experience will teach. Note that changing the speed will change the fold length slightly. As the paper hits the paper stop at higher speeds, it will compress more before buckling and entering the fold rollers; resulting in a longer fold.

Hint: when setting the paper stops, keep in mind the desired fold speed to avoid excessive re-adjustments.

3.7 Setting the Accessory Assembly

The exit rollers are adjustable to accommodate different widths of paper. Typically, they are positioned so one to two inches of paper is exposed on each side. To adjust the space between them, use the dejam handle to rotate the shafts into a position where the set screws are accessible. Loosen the screws in the hubs with the 5/32" hex wrench and slide them on the shaft to the desired position and re-tighten. See Fig. 12

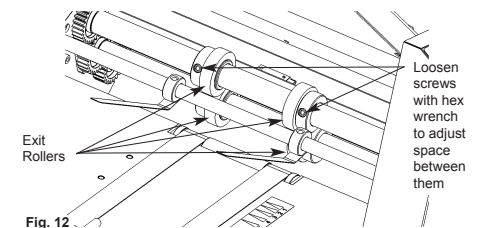

Fig. 12

The guide fingers are used to assist the stacking wheels in producing a neat stack. Typically, they are positioned on the outside of the wheels and lightly on top of the stream of folded stock. They are adjustable in the same manner as the exit rollers but with the 1/8" hex wrench.

The Accessory Assembly is held in place using the same pins and slots method as the other assemblies. It is easily removed for service by pressing the two white lock tabs simultaneously.

The assembly will then drop down onto a set of pins. From there, grab the top large shaft with both hands and pull the accessory assembly out at the same angle as the lock tabs. See Fig. 13 & 18

Note: to simplify removal, first remove the 1st fold plate assembly, loosen and rotate the guide fingers up off the conveyor table several inches and flip the stack wheels back out of the way.

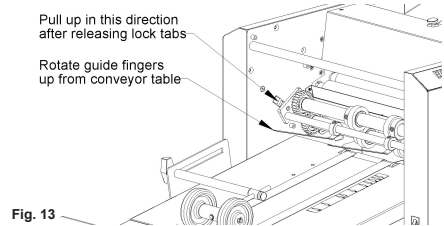

Fig. 13

To remove exit rollers or guide finger collars for service, or to add or remove accessories such as perforators and scoring wheels, simply remove the flat head screw on the right side of the assembly using the 5/32" hex wrench. Slide the right bearing plate off the two accessory shafts to gain access to the accessories. Be careful not to twist the assembly when disassembling/reassembling as it may not re-align properly on the mounting pins. The upper and lower components must be added and removed together. The scoring hub can be mounted on either the lower accessory shaft or the upper as shown. See Fig. 14.

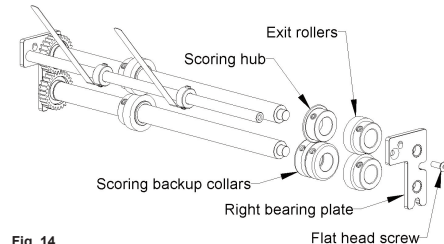

Fig. 14

The scoring backup collars have two sizes of radius edges to allow more versatility for different paper weights. An optional thicker scoring hub is also available. Choose the desired radius and match them on either side of the scoring hub when installing. Tighten the scoring hub in the desired position first. Position the scoring backup collars evenly on either side, leaving a gap. Adjust the width of the gap to get the desired scoring results. See Fig. 15

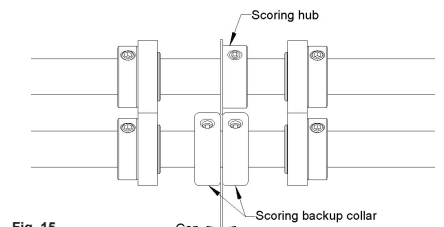

Fig. 15

Warning! The perforating blade is very sharp, handle with care. The perforating blade must always be mounted on the upper accessory shaft. Be sure to include the stripper finger provided as this will prevent the paper from clinging to the blade and creating jams or irregular stacking.

Install the perforator blade and backup hub onto the accessory shafts together, engaging the blade in the correct groove in the backup hub. The narrow groove is for thinner blades (.031" thick) and the wide groove is provided for optional thicker blades (.063" thick). See Fig. 16

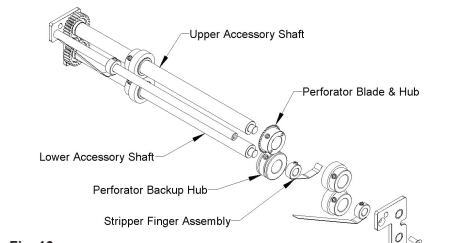

Fig. 16

The perforating blade must be positioned with the flat side against the edge of the groove in the backup hub. Tighten the perforator blade hub in the desired position first, then position the backup hub against it and tighten it last. Be careful not to put excessive tension between the blade and hub as it will cause premature wear on the cutting surfaces. Next, position the stripper finger between the perforator blade hub and the backup hub, leaving enough of a gap between the finger and backup hub for the paper to pass easily. See Fig. 17

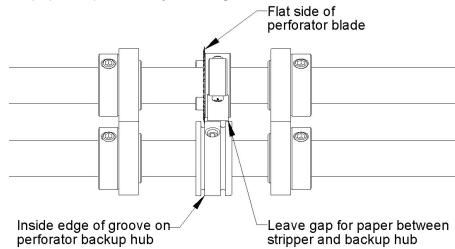

Fig. 17

To return the assembly into the machine, follow the same path as when removing it, directly over the lock tabs. Engage the two lower pins first, and then rotate forward until it locks into position. See Fig. 18

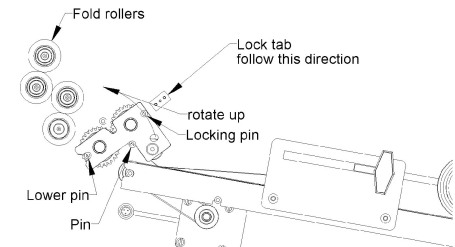

Fig. 18

3.8 Setting the Air Controls

The Pump is provided with Pressure and Vacuum adjustment knobs that, by default, are set at their maximum value. See Fig. 19

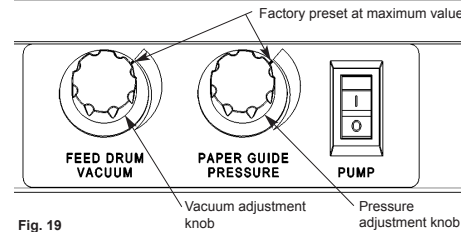

Fig. 19

For most folding applications, no further adjustment is necessary. Located on the Right Side Cover are fine adjustment valves to reduce the vacuum and/or pressure to the Feed Drum and Paper Guides if needed. The Right Side Cover is also equipped with an ON/OFF switch and circuit breaker for the pump. For the most common paper sizes and weights, maximum vacuum to the Feed Drum is desirable. As paper is fed over the holes in the Feed Drum, the vacuum gauge will peak between 13-15 in/hg. See Fig. 20

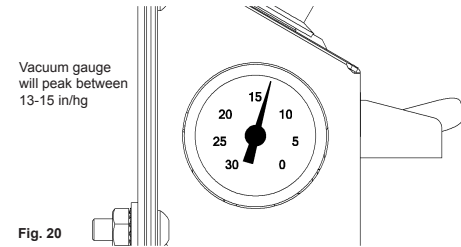

Fig. 20

Opening the Vacuum Adjustment Knob will cause less vacuum on the Feed Drum and lower readings on the gauge. When running without paper on the Feed Drum, the gauge will drop to near 0. Lower vacuum levels may be desired when feeding light-weight paper.

Air pressure from the Paper Guides is critical to "floating" the stack of paper placed upon the Feed Table. This allows the bottom sheet to be easily pulled by the Feed Drum without the friction of the remaining stack dragging on it. For best results, a balance between paper size, weight, and stack height, along with the amount of air flow, must be met. Hint: for large jobs, use more air and continually fill the Feed Table. On small jobs, it may be easier to decrease the air flow and paper stack height as the paper will flutter more as the stack runs out.

4.0 General Operation

When the folder has been properly setup and adjusted, turn ON the main power switch (I/O); the counter will come on with "000000".

Note: when the main power switch is turned OFF, any present counter readings will be reset to zero when turned back ON. The counter reads the material as it exits the fold rollers and can be reset to zero at any time by pushing the reset button. By holding the button down for a few seconds, it will display the total "life" count times 1,000. For example, until the first 1,000 has

been counted it will read "0". From 1000 to 1,999 it will read "1".

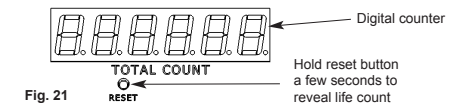

Fig. 21

Next, turn the fold speed and conveyor speed dials to the desired setting. The two speed control knobs, folding speed and conveyor speed are numbered from 1-8 for reference purpose. The folding speed control includes an ON/OFF function for both motors, while the conveyor control only adjusts the speed. Using the folding speed control ON/OFF function does not reset the counter if the main power switch is left ON. See Fig. 22

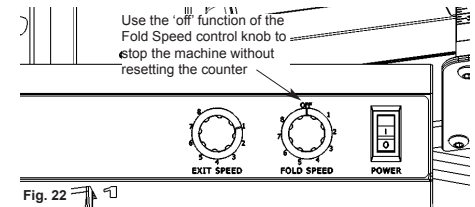

Fig. 22

Begin folding by placing a stack of paper onto the feed table with the roller motor and pump off. Turn the pump on and make sure the air flow is sufficient to "float" the stack. Place the Paper Back Stop against the back side of the stack to prevent the bottom sheets from blowing away from the Separator. Turn on the roller motor to begin the folding operation. **Always check that the stack wheels are in the correct position before inserting paper!** The paper stack is automatically fed and folded, depending on the fold plate setup and delivered onto the conveyor in an overlapping row.

4.1 Single Folds

(Refer to Section 3.3) Single folds require one fold plate to be in the fold position and one to be in bypass position. Single folds are typically made in the 1st Fold Plate as they tend to be more accurate. Heavier stock may perform better when single folded in the 2nd Fold Plate if curling becomes an issue, provided the desired fold length is not over 11". See Fig. 23

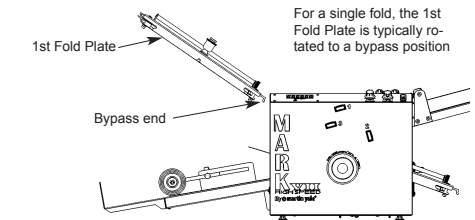

Fig. 23

4.2 Double Folds

(Refer to Section 3.3) Double folds require both fold plates to be in the fold position. Depending on which fold is made first will determine the configuration of the fold. For example, a Z fold and a letter fold are basically the same; the sheet being folded into thirds. For a Z fold, both fold plate paper stops are set to 1/3 the