

Formax FD342 Tabletop Document Folder

Instruction Manual

For Models:

CoilMac ECI 4:1 Coil

CoilMac ECI 5:1 Coil



Provided by

MyBinding.com
When Image Matters.

Call Us at 1-800-944-4573

FORMAX[®]

FD 342

Document Folder

OPERATOR MANUAL
FIRST EDITION

TABLE OF CONTENTS

SUBJECT	PAGE
DESCRIPTION	1
SPECIFICATIONS	1
UNPACKING	2
SETUP	2
CONTROL PANEL	3
OPERATION	4
SETTING CUSTOM FOLDS	5
BATCH COUNTING	5
MULTI-SHEET FEEDING (OPTIONAL)	6
CROSS FOLDING	7
STACKER WHEEL POSITIONING CHART	7
STACKER WHEEL SETUP FOR THICK PAPER	8
REMOVING OUTFEED COVER	8
REMOVING INFEED TIRES	9
OPERATOR MAINTENANCE	9
TROUBLE-SHOOTING	10



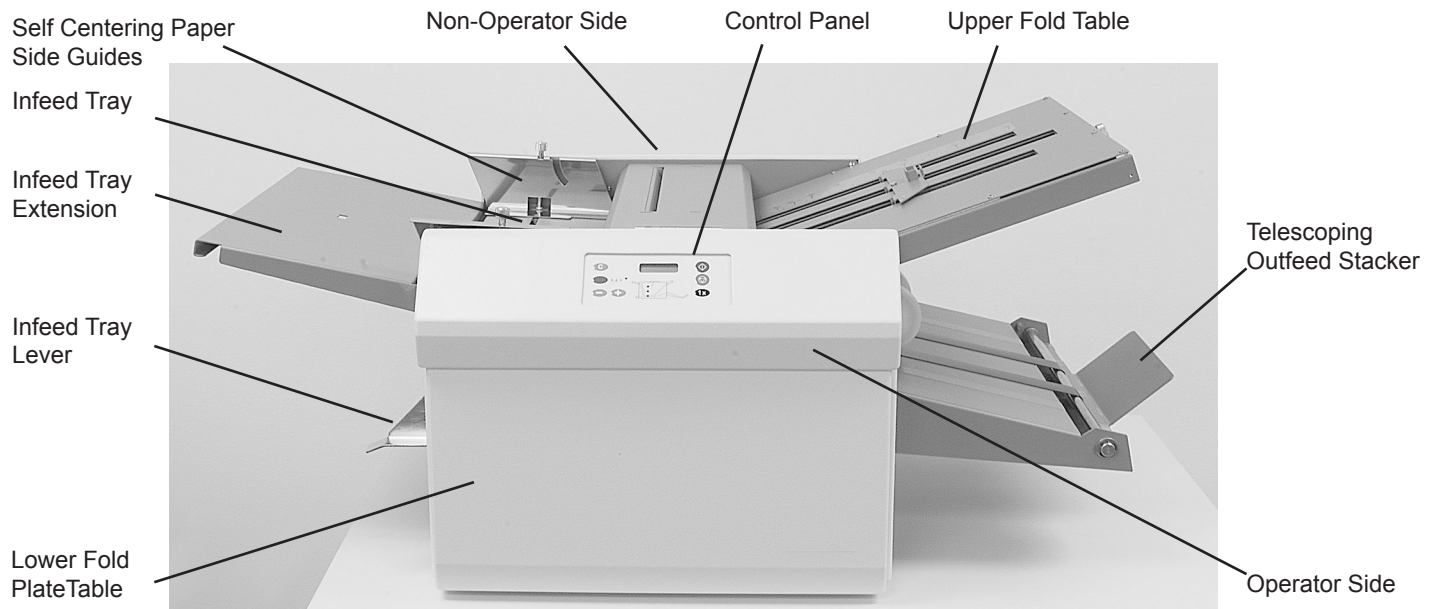



DESCRIPTION



FUNCTION

The FD 342 Folder is designed to perform a wide variety of folds using a variety of paper weights. The fold plates are manually adjusted for standard folds and custom folds. Batch counting, self-centering side guides, and the capability to cross-fold are added features. The folder will automatically stop after the last document has been folded.

SPECIFICATIONS

Speed:	Standard Mode: Up to 15,500/hour, depending on fold type
Hopper Capacity:	Up to 500 sheets of 20# paper (75gsm)
Paper size:	Min: 3.5" X 5" (88.9 W x 127 L mm) Max: 12.25" X 18" (311 W x 457 L mm)
Pre-Marked fold types:	Letter  , Zig-Zag  , Single  , Gate  , Fold Out  , Double Parallel 
Pre-Marked Paper Sizes:	FD Model: 11", 14", 17" FE Model: A5, A4, A3, B6, B5, B4
Dimensions	Closed: 33" L x 20" W x 19" H (84 L x 51 W x 48 H cm) Fully Extended: 60"L x 20" W x 19" H. (152 L x 51 W x 48 H cm)
Weight:	67 lbs (30 kg)
Power:	FD Model: 120 volts A.C., 50/60 Hz, 2.5 amps. FE Model: 220 volts A.C., 50/60 Hz, 2 amps
Safety Certifications:	UL & CE Applied For

UNPACKING & SETUP

1. Check package for shipping damage. If there is shipping damage, do not discard the box.
2. Remove the machine and packed components from the box. The fold plates, telescoping stacker, Optional Multi Sheet Feeder if ordered, power cord and cross-fold guide are wrapped separately in the box.

NOTE: Two people must lift the machine from the box.

3. Place the folder on a solid stand.

Install upper and lower fold plates, telescoping conveyor multi-sheet feeder and power cord

1. Be sure the plates are set firmly on the locating pins (Fig 1a & 1b). Slide each fold plate in until it meets the first locating pin then push down to set in place.

Upper Fold Table Pins



Fig. 1a

Locating Pins

2. Repeat the same steps for the lower fold plate.

Lower Fold Table Pins

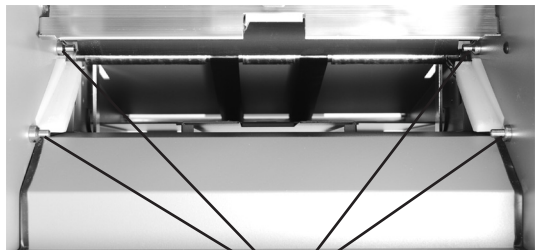

Fig. 1b

Locating Pins

3. Insert the telescoping extension tray into the end of the outfeed conveyor (Fig. 2).

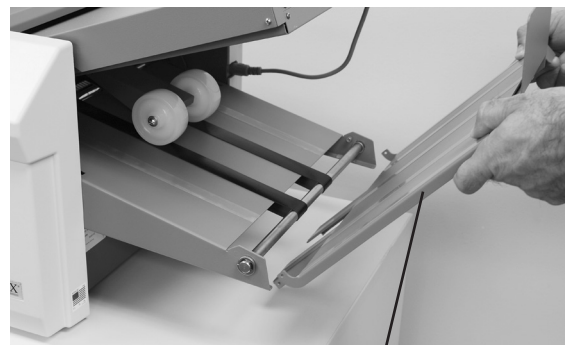

Fig. 2

Telescoping extension tray

4. If equipped, insert the optional Multi-Sheet Feeder into the four slots located on the top cover (Fig 3).

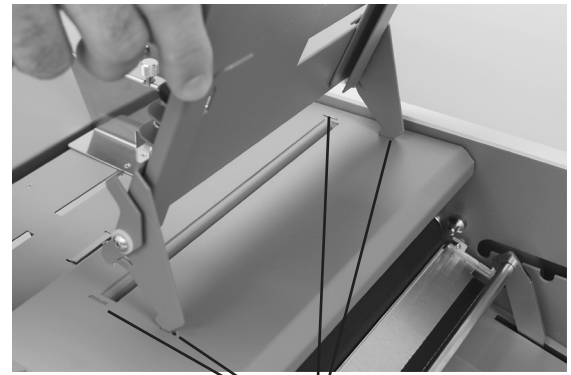
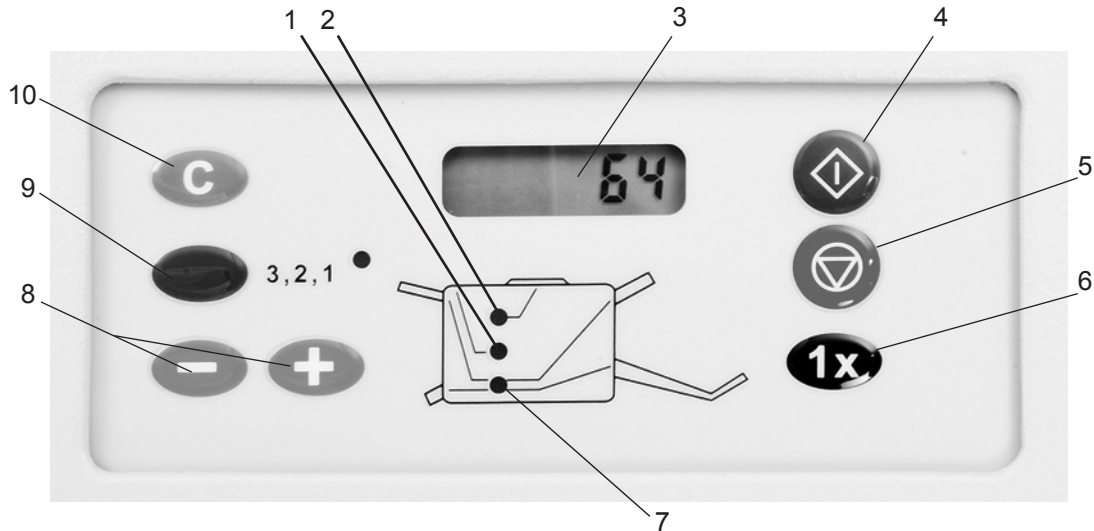

Fig. 3

4 Slots

5. Make sure the power switch is in the “OFF” position. Plug the power cord into the power inlet and the wall outlet.

CONTROL PANEL



No.	NAME	FUNCTION
1	Paper out indicator	Lights up when paper needs to be loaded
2	Cover open indicator	Lights up when top cover is open
1	Counter Display	Shows the number of documents processed. When power is turned on it displays “F-01”.
2	Start Button	Press to start the folder.
3	Stop Button	Press to stop the folder.
4	Test Button	Test folds one document.
5	Fault Indicator Lights	Stops the operation and indicates the problem area, check for paper in the areas indicated, clear paper and press the “C” button to turn off the “Fault detect” lights.
6	Batch Counting Button	Select the batch counting function.
7	“-“ and “+” buttons	Select the number of documents to be batch folded.
8	Clear / Reset Button	Resets the fault detect circuit and the counter. CAUTION: when a fault occurs, only press the button one time. If pressed a second time, the counter will be reset.

OPERATION

1. Place power switch in the "ON" position.
2. To set the fold plate stop position, squeeze the stop plate lever and move the stop plate to the desired location on the upper and lower fold plates (Fig 4). Align the pointed part of the stop plate with the desired marks on the decal and release the lever. Fine adjustments can be made with the adjustment knob at the end of the plate (Fig 5).

NOTE: When doing a "Single" fold, be sure to move the lower fold plate stop all the way to the front of the plate. The plate must be firmly reinstalled on the locating pins.



Fig. 4



Fig. 5

3. Move the stacker wheels to the proper position for the paper size (Fig 6) (Refer to chart on page 7).
4. Extend the telescoping conveyor stacker as required.
5. Lift the in-feed tray extension into position.
6. Raise the in-feed tray lever.
7. Set the paper side guides for the paper you're using and lock in position.
8. Neatly stack paper on the in-feed tray.
9. Lower the in-feed tray lever.
10. Press the "Test" button on the control panel to check the folds. Adjust as needed.
11. If the fold is skewed use the skew adjustment knob to make corrections (Fig.7).
12. When you're satisfied with the test folds, press the "Start" button to operate the machine.

Stacker Wheel Positions A, B & C

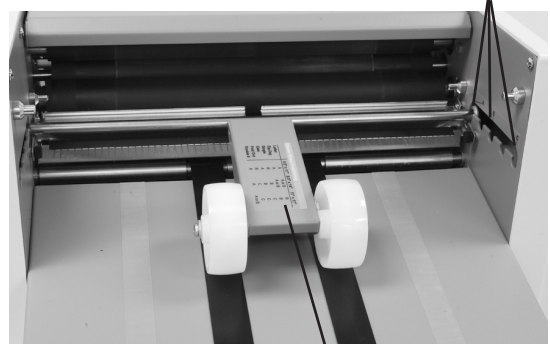

Fig. 6

Stacker Wheels



Fig.7

Skew Adjuster

SETTING CUSTOM FOLDS

Example 1: Uneven “Z”

1. Measure the length of panel “A”
2. Adjust the upper fold plate so that the stop plate lines up with the measurements of the panel “A” i.e. if panel “A” is 5 1/4” long slide the stop plate up or down so that it lines up with the 5 1/4” mark on the fold plate.
3. Measure the length of panel “B”
4. Adjust the lower fold plate so that the stop plate lines up with the measurement of panel “B”
5. Load forms and press test. If folds are too long or too short adjust accordingly.

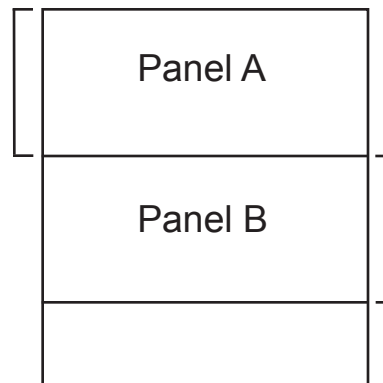

Example 2: Uneven “C”

1. Measure the length of panel “A” & “B”
2. Adjust the upper fold plate so that the stop plate lines up with the measurements of panel “A” & “B”. i.e. if panel “A” & “B” are 10 1/2” long slide the stop plate up or down so that it lines up with the 10 1/2” mark on the fold plate.
3. Measure the length of panel “B”
4. Adjust the lower fold plate so that the stop plate lines up with the measurement of panel “B”
5. Load forms and press test. If folds are too long or too short adjust accordingly.

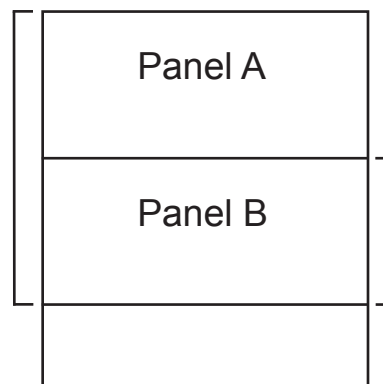

BATCH COUNTING

The batch counter can be set from “0” to “999”. Press the “Batch Counting” button to illuminate the “Batch Counting” light. Press the “-” or “+” buttons to select the number of documents to be folded (Fig 8). Press the “” button. When the counter gets to “0” the machine will stop.

NOTE: The batch counting program will remain on after turning the power off. You *must* press the Batch Counting button to turn off the light and cancel the batch count setting.

Batch Count Button Batch Count Indicator Light

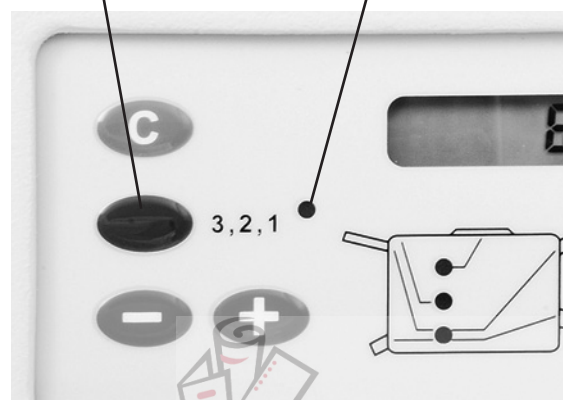

Fig. 8

MULTI-SHEET FEEDING (OPTIONAL)

The multi-sheet feeder is designed to fold pre-collated stapled or unstapled sets of up to four 20 # (75gsm) sheets of paper.

1. Adjust the side guides on the multi-sheet feeder for the proper paper size. Loosen the brass thumb screw, adjust the guides to fit the paper width and re-tighten the thumbscrew (Fig 9a).



Fig. 9a

Brass thumbscrew

2. Slide the pre-collated paper set into the multi-sheet feeder. When feeding stapled sets the documents should be placed with the staple on the operator's side and leading (Fig 9b).

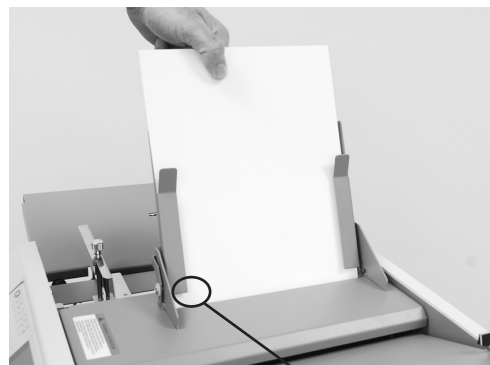

Fig. 9b

Staple

3. The sheets of paper will be automatically pulled into the folder (there is a one-second delay after the paper is placed in the feeder).

4. If the fold is skewed, turn the skew adjustment knob located on the back of the feeder left or right to make corrections (Fig 9c).



Fig 9c

Skew Adjuster

5. To remove the multi-sheet feeder depress the release levers located on either side of the lower back side of the feeder (Fig. 9d), tilt the feeder forward and lift. To reinstall depress the levers and reinsert.

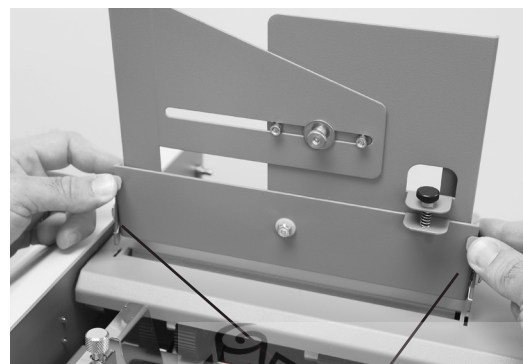

Fig. 9d

Release Levers

CROSS FOLDING

Cross folding refers to folding a document in one pass and then running it through the folder a second time to be folded again.

Common Application: Folding a 11" x 17" document in half and then letter folding it to fit in a standard #10 envelope.

1. Load folded paper into the feed tray with the fold crease facing the non-operator side of the folder (Fig 10a).

Note: For best results, firmly run your hand over the fold crease to help flatten the paper before loading.

2. Attach the cross fold paper guide onto the feed tray paper guide (Fig. 10b) and lower guide.

Note: Cross folding ability will vary based on the paper weight and type. If the paper is too heavy it may not be able to be cross folded.

Note: The guide can be conveniently stored under the lower fold table when not in use (Fig 10c).

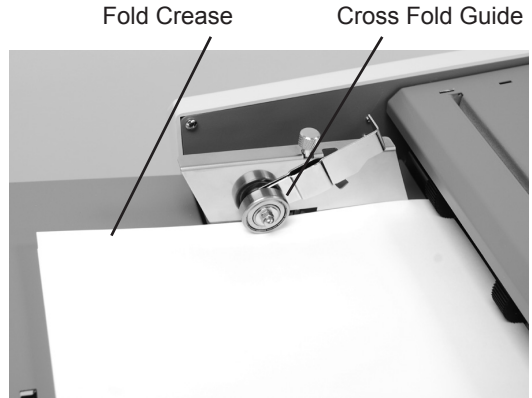

Fig. 10a

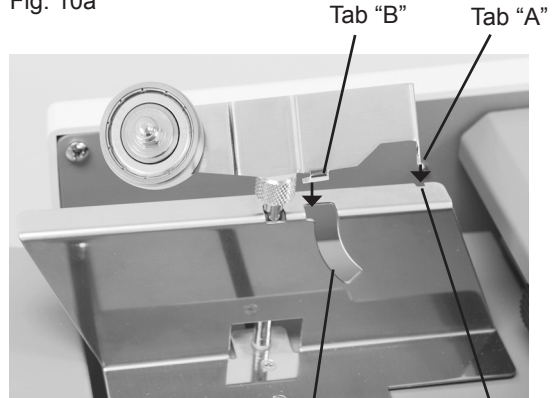

Fig. 10b

To install cross fold guide hook tab "A" into slot "A" and then lower tab "B" into slot "B"



Fig. 10c

Cross fold guide storage

STACKER WHEEL POSITIONING GUIDE

Move the stacker wheels to the proper position indicated on the chart based on the fold and paper size (Fig 11a and 11b).

	8.5" x 11"	8.5" x 14"	11" x 17"
Letter	A	A or B	B
Zig-Zag	A	A or B	B
Single	B	B	C
Gate	A	B	C
Fold Out	B	C	C
Double II	A	A	A or B

Fig. 11a

Stacker wheels decal

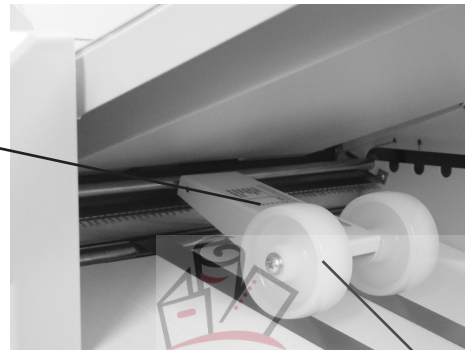

Fig. 11b

STACKER WHEEL SETUP FOR THICK PAPER

Thicker paper from 28 # up to 65 # may require special stacker wheel setup moving the stacker wheels closer than the position "A" slot.

If stacking is inconsistent move the stacker wheels from the standard position #1 (Fig. 12a) to the thick paper weight position #2 (Fig. 12b) as indicated in the pictures below, position # 2 may also be good for small folded documents.

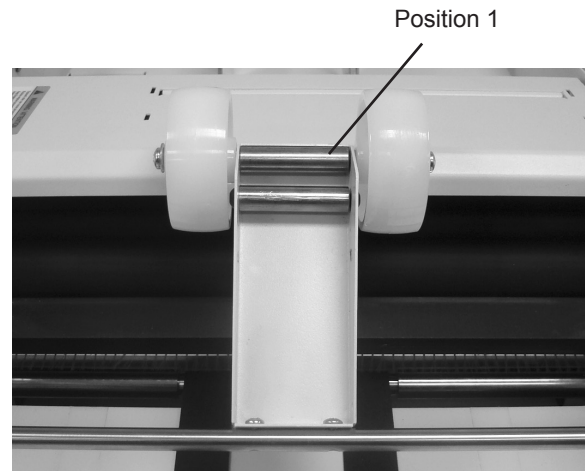

Fig. 12a - Standard Stacker Wheel Position

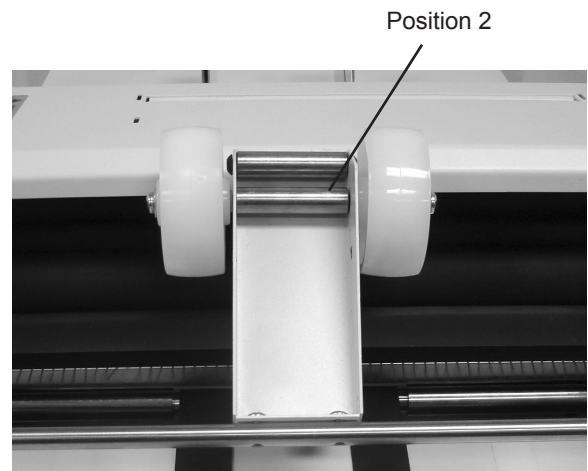

Fig. 12b - Thick Paper Weight Position

REMOVING OUTFEED COVER

The outfeed cover can be removed to access the exit roller. To remove, unscrew thumbscrews that hold the cover in place (Fig. 13)

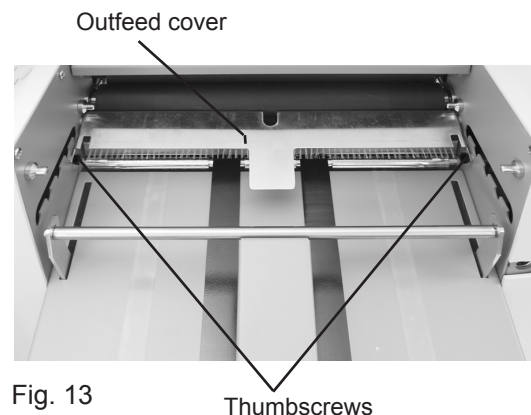

Fig. 13

REMOVING INFEED TIRES

The infeed tires can easily be removed for cleaning and replacement. Remove the Allen screw located on the left side of the feed tire shaft (Fig. 14a). Slide the shaft to the right to release from the side frame and remove (Fig. 14b).

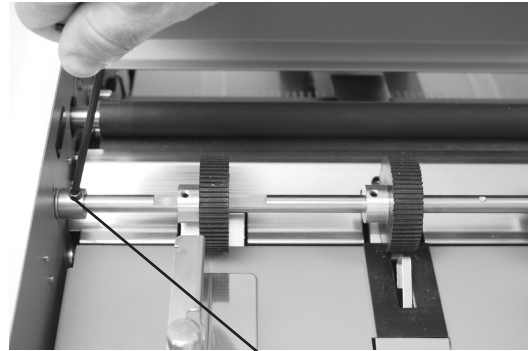

Fig. 14a Allen Screw



Fig. 14b

OPERATOR MAINTENANCE

1. It is recommended to let forms cool for one-half hour, from the laser printer, before folding. This allows toner to set on the forms and static electricity to discharge. The FD 402 Jogger is recommended for best results. The Jogger squares the forms and dissipates heat and static electricity created by laser printers.
2. Clean in-feed tires and fold rollers with Formax recommended roller cleaner & rejuvenator to remove paper dust and toner. A Formax Cleaner Kit is available from your dealer. A damp cloth with water is the best alternative.

CAUTION: Do not use any chemicals other than the roller cleaner & rejuvenator or water.

CLEANING PROCEDURES:

1. Make sure machine is turned off and unplugged. All folders have four (4) rubber rollers (Fig. 15).
2. Remove the upper and lower fold plates.
3. Using Formax roller cleaner, spray a new cotton cloth until the cloth is saturated. Wipe the wet cloth in a back and forth motion making sure to clean the entire surface of the fold and seal rollers. Next use a dry cloth and wipe off excess toner. The cloth should be covered with black toner surplus from cleaning the rollers.
4. Run 10-15 sheets of blank copy paper through the folder to ensure all cleaner has been removed from the fold rollers. Running blank sheets will remove any excess residue of cleaner on the rollers.

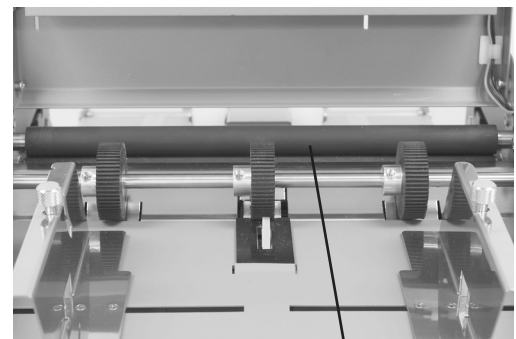

Fig. 15 Fold Rollers

TROUBLE-SHOOTING

TROUBLE	POSSIBLE CAUSE	REMEDY
Control panel lights are not illuminated.	No power at the wall outlet.	Check wall outlet.
	No power to the machine inlet.	Check power cord for frayed/broken wires.
	No power to the control panel.	Press the button on the circuit breaker.
	Internal electrical failure	Call for service
"Cover Open" light is on.	Cover open	Close cover
	Magnetic switch is broken.	Call for service
"Paper out " light is on.	In-feed tray is empty.	Place documents on the in-feed tray.
"Fault detect" light is on.	Paper misfeed	Reload paper and press "Reset".
	Paper jammed at exit of folder.	Remove paper and press "Reset".
Black marks on the folded paper.	In-feed tires, separator, and/or fold rollers are dirty.	Clean the parts with approved roller cleaner and rejuvenator.
Fold is skewed.	In-feed tray is out of adjustment.	Turn skew adjuster knob to remove the skew.
Stacker belts do not turn.	Broken drive belt, worn drive gear.	Call for service
Documents are wrinkled or crunched.	Fold plates are not inserted correctly.	Remove and reinstall fold plates. Be sure they're properly positioned.
	Piece of paper or other material is stuck in the fold plate.	Remove object from the fold plate.
In-feed tray lever does not work	Broken spring	Call for service
Double feeding forms	Documents stuck together	Jog forms to remove static electricity.
	Feed tire or separator worn	Call for service
Not feeding documents	Feed tire dirty	Clean feed tire
	Feed tire or separator worn	Call for Service